



Dean Stoves

Eco Stoves
Handmade
by Craftsmen



www.deanforge.co.uk

MADE IN
BRITAIN



Dartmoor 5 *Eco*

The Dartmoor 5 Eco 5kw wood burning stove offers performance and efficiency. This compact Eco 2022 compliant stove includes a powerful Airwash system for a clearer view of the fire, and has been developed to allow a distance to combustibles of only 150mm to the rear. An ideal choice for smaller fireplaces.



Key Features

- Eco 2022 Compliant (Ecodesign Ready)
- 5Kw nominal output
- Wood burner and Multi-fuel models with riddling grate available
- Can be fitted onto a non-constructural hearth
- Fitted with rear and base protector as standard
- Supplied as a wood burner or a multi-fuel and option to convert at any time back to a multi-fuel or wood burner if required
- Black handle supplied as standard or optional stainless steel handle
- **APPROVED** for use in smoke control areas.



Dartmoor 5 Eco 5Kw wood burning stove

Dartmoor 5 Eco

NOMINAL STOVE OUTPUT	WIDTH	HEIGHT	DEPTH O/A	DEPTH WITH HANDLE	FLUE SIZE	FLUE CENTRE TOP (A)	FLUE CENTRE (B)	STANDARD LEG LENGTH	EFFICIENCY	ENERGY EFFICIENCY CLASS
5Kw	430mm	540mm	315mm	375mm	125mm	133mm	438mm	50mm	82.1%	A+

Dartmoor W5 *Eco*

The Dartmoor W5 Eco 5kw wood burning stove, with efficient Eco 2022 performance, has been developed to allow a distance to combustibles of only 50mm to the rear**. The wide door offers an excellent view of the fire. An ideal choice for smaller rooms with larger fireplaces.



Dartmoor W5 Eco 5kw wood burning stove

Key Features

- Eco 2022 Compliant (Ecodesign Ready)
- 5Kw nominal output
- New improved powerful Airwash system
- Wider door
- **with double heat shield fitted
- Fitted with rear and base protector as standard
- Supplied as a wood burner or a multi-fuel and option to convert at any time back to a multi-fuel or wood burner if required
- Can be fitted onto a non-constructural hearth
- **APPROVED** for use in smoke control areas.

Dartmoor W5 Eco

NOMINAL STOVE OUTPUT	WIDTH	HEIGHT	DEPTH O/A	DEPTH WITH HANDLE	FLUE SIZE	FLUE CENTRE TOP (A)	FLUE CENTRE (B)	STANDARD LEG LENGTH	EFFICIENCY	ENERGY EFFICIENCY CLASS
5Kw	565mm	640mm	320mm	375mm	125mm	133mm	475mm	105mm	83.1%	A+



What is Eco 2022 Compliant?

Eco 2022 Compliant (Ecodesign Ready) is the stove industry's response to the DEFRA Clean Air Strategy, which aims to improve air quality and reduce emissions/pollution by 2022. The Clean Air Strategy aims to tackle three key areas; limit the sale of polluting fuels, improve the efficiency of stoves and update legislation relating to Smoke Control Areas. Dean Stoves Eco stoves are independently tested by an approved test laboratory to meet the strict emissions and efficiency criteria of the Eco 2022 Clean Air efficiency standards.

Dartmoor 8

**Eco model under development*



Key Features

- Large glass door with all the features of the Dartmoor 5 and W5 models
- Powerful Airwash system, designed to create a clearer view of the fire by creating combustion over the glass
- Wood burner and Multi-fuel models available
- Optional kit to convert the Wood burner model to burn smokeless fuels at a later date
- Rear and Base protection plates not normally required unless the stove is being sited on a heat sensitive hearth material such as Slate or Marble.

Dartmoor 8 in Mushroom

Dartmoor 8

NOMINAL STOVE OUTPUT	WIDTH	HEIGHT	DEPTH O/A	DEPTH WITH HANDLE	FLUE SIZE	FLUE CENTRE TOP (A)	FLUE CENTRE (B)	STANDARD LEG LENGTH	EFFICIENCY	ENERGY EFFICIENCY CLASS
8Kw	565mm	640mm	343mm	375mm	150mm	115mm	475mm	105mm	74.9%	A

Huccaby *Eco* and Foxworthy *Eco* *High & Low*

The Huccaby Eco and Foxworthy Eco, part of the Dartmoor Eco Range, offer the advantages of elevated 5Kw stoves with solid, elegant legs.

With the presence of a big stove and lower output, these Eco stoves are ideal for a larger fireplace within a room that needs 5Kw or less. In addition, the Huccaby Eco has been developed to allow a distance to combustibles of only 50mm to the rear.** The Foxworthy Eco has two optional leg lengths.



Huccaby Eco



Foxworthy Low Eco

Huccaby Eco Key Features

- Eco 2022 Compliant (Ecodesign Ready)
- 5Kw nominal output
- Large glass window
- New improved powerful Airwash System
- Wood burning or multi-fuel option
- **APPROVED** for use in smoke control areas.
- **with double heat shield fitted.

Foxworthy Eco Key Features

- Eco 2022 Compliant (Ecodesign Ready)
- 5Kw nominal output
- Large glass window
- New improved powerful Airwash System
- Wood burning or multi-fuel options
- **APPROVED** for use in smoke control areas.



Foxworthy High Eco

Huccaby Eco

NOMINAL STOVE OUTPUT	WIDTH	HEIGHT	DEPTH O/A	DEPTH WITH HANDLE	FLUE SIZE	FLUE CENTRE TOP (A)	FLUE CENTRE (B)	STANDARD LEG LENGTH	EFFICIENCY	ENERGY EFFICIENCY CLASS
5Kw	565mm	785mm	320mm	375mm	125mm	133mm	620mm	250mm	83.1%	A+

Foxworthy Low Eco

NOMINAL STOVE OUTPUT	WIDTH	HEIGHT	DEPTH O/A	DEPTH WITH HANDLE	FLUE SIZE	FLUE CENTRE TOP (A)	FLUE CENTRE (B)	STANDARD LEG LENGTH	EFFICIENCY	ENERGY EFFICIENCY CLASS
5Kw	430mm	690mm	315mm	375mm	125mm	133mm	588mm	200mm	82.1%	A+

Foxworthy High Eco

NOMINAL STOVE OUTPUT	WIDTH	HEIGHT	DEPTH O/A	DEPTH WITH HANDLE	FLUE SIZE	FLUE CENTRE TOP (A)	FLUE CENTRE (B)	STANDARD LEG LENGTH	EFFICIENCY	ENERGY EFFICIENCY CLASS
5Kw	430mm	790mm	315mm	375mm	125mm	133mm	688mm	300mm	82.1%	A+

Woodbury 5 *Eco*

The new Eco 2022 Woodbury Range of stoves.

The Woodbury 5 Eco, a highly efficient 5Kw wood burning stove with clean lines and new slimline door maintains an excellent view of the fire. The Woodbury 5 Eco has attractive features including elegant but robust legs, and its stylish modern looks will enrich any traditional or modern home.



Woodbury 5 Eco Key Features

- Eco 2022 Compliant (Ecodesign Ready)
- Primary and secondary air controls
- Exceptional Clearburn pre-heated Airwash system
- Approved for use in smoke control areas
- Wood or Multi-fuel stove options
- Cool touch stainless steel door handle
- Stainless steel Airwash control knobs as standard
- Closed combustion option
- Rear or top flue outlets

Woodbury 5 Eco

Woodbury 5 Eco

NOMINAL STOVE OUTPUT	WIDTH	HEIGHT	DEPTH O/A	DEPTH WITH HANDLE	FLUE SIZE	FLUE CENTRE TOP (A)	FLUE CENTRE (B)	EFFICIENCY	ENERGY EFFICIENCY CLASS
5Kw	460mm	635mm	345mm	395mm	125mm	135mm	490mm	82.4%	A+

Woodbury Slimline 5 Eco

The new Woodbury Slimline 5 Eco, standing on elegant shaped legs, offers 5Kw high efficiency, clean lines and a new slimline door with a large window maintaining an excellent view of the fire. Wood or multi-fuel options are available and are 2022 compliant (Ecodesign Ready). With its stylish modern looks it will enhance any contemporary home today. The Woodbury 8 Eco is supplied as a wood burning stove only.

Woodbury Slimline 5 Eco Key Features

- Eco 2022 Compliant (Ecodesign Ready)
- Primary and secondary air controls
- Cool touch stainless steel door handle
- Exceptional Clearburn pre-heated Airwash system
- Approved for use in smoke control areas
- Wood or Multi-fuel stove options
- Stainless steel Airwash control knobs as standard
- Closed combustion option
- Rear or top flue outlets



Woodbury Slimline 5 Eco

Woodbury Slimline 5 Eco

NOMINAL STOVE OUTPUT	WIDTH	HEIGHT	DEPTH O/A	DEPTH WITH HANDLE	FLUE SIZE	FLUE CENTRE TOP (A)	FLUE CENTRE (B)	EFFICIENCY	ENERGY EFFICIENCY CLASS
5Kw	585mm	635mm	325mm	375mm	125mm	135mm	490mm	81.4%	A+

Woodbury 8 Eco

NOMINAL STOVE OUTPUT	WIDTH	HEIGHT	DEPTH O/A	DEPTH WITH HANDLE	FLUE SIZE	FLUE CENTRE TOP (A)	FLUE CENTRE (B)	EFFICIENCY	ENERGY EFFICIENCY CLASS
8Kw	585mm	635mm	385mm	445mm	150mm	145mm	495mm	75.1%	A

Croft Clearburn

Junior *Eco* & Slimline 5 *Eco*

The Croft range of Clearburn Eco stoves are designed on simple clean-cut lines and will grace any home, old or new.

As with all our Clearburn Eco wood burning stoves, the substantial double-glazed door panel and pre-heat Airwash system provide a stove that is more environmentally friendly. The Eco 2022 compliant Croft Junior, Slimline 5 and Croft Small are approved for use in smoke control areas.

The Croft Clearburn Eco Range has the option of profiled flat top or rolled edge flat top. Standard is with a black bar handle and black secondary air control knob, and can be ordered with cage or stainless steel bar handles and brass or stainless steel secondary air control knob. See illustrations on page 21.

Key Features

- Eco 2022 Compliant (Ecodesign Ready)
- 5Kw Nominal Output
- Individual Primary & Secondary air controls
- Top and rear flue outlets
- **APPROVED** for use in smoke control areas.



Profiled top Slimline 5 Eco

Croft Clearburn Junior Eco with profiled flat top

Croft Clearburn Junior Eco

CANOPY TYPE	NOMINAL STOVE OUTPUT	WIDTH	HEIGHT	DEPTH O/A	DEPTH WITH HANDLE	FLUE SIZE	FLUE CENTRE TOP (A)	FLUE CENTRE (B)	STANDARD LEG LENGTH	EFFICIENCY	ENERGY EFFICIENCY CLASS
Profiled Flat Top	5Kw	460mm	635mm	380mm	395mm	125mm	135mm	490mm	100mm	82.4%	A+
Rolled edge Flat Top	5Kw	490mm	635mm	380mm	395mm	125mm	135mm	490mm	100mm	82.4%	A+

Croft Clearburn Slimline 5 Eco

CANOPY TYPE	NOMINAL STOVE OUTPUT	WIDTH	HEIGHT	DEPTH O/A	DEPTH WITH HANDLE	FLUE SIZE	FLUE CENTRE TOP (A)	FLUE CENTRE (B)	STANDARD LEG LENGTH	EFFICIENCY	ENERGY EFFICIENCY CLASS
Profiled Flat Top	5Kw	585mm	635mm	360mm	382mm	125mm	135mm	490mm	100mm	81.4%	A+
Rolled edge Flat Top	5Kw	622mm	635mm	360mm	382mm	125mm	135mm	490mm	100mm	81.4%	A+

Croft Clearburn Small *Eco*

As with all the Clearburn Eco Range the Croft Clearburn Small Eco 8Kw has an exceptional pre-heated Airwash system for a clearer view of the fire.

The Croft Small Eco and the Slimline 5 Eco (see opposite) are essentially the same stove, except that the Croft Slimline 5 Eco has a reduced depth. This lowers the Kw output but retains the large glass door and wide fire box for maximum view of the fire. Both the Clearburn Small Eco and Slimline 5 Eco are **APPROVED** for use in smoke control areas.

The Clearburn Small Eco is Eco 2022 compliant and has an option of either a Rolled Edge Flat Top or a Profiled Flat Top. The Clearburn Eco Small featured here has a Rolled Edge Flat Top.

Croft Clearburn Small Eco with rolled edge top – also available in profiled top, see illustrations on page 23.

Croft Clearburn Small Eco

CANOPY TYPE	NOMINAL STOVE OUTPUT	WIDTH	HEIGHT	DEPTH O/A	DEPTH WITH HANDLE	FLUE SIZE	FLUE CENTRE TOP (A)	FLUE CENTRE (B)	STANDARD LEG LENGTH	EFFICIENCY	ENERGY EFFICIENCY CLASS
Profiled Flat Top	8Kw	585mm	635mm	420mm	442mm	150mm	145mm	500mm	100mm	75.1%	A
Rolled edge Flat Top	8Kw	622mm	635mm	420mm	442mm	150mm	145mm	500mm	100mm	75.1%	A

Croft Clearburn

Medium & Large



Croft Medium with rolled edge top



Croft Medium with profile top

The Croft Medium and Croft Large are the largest output stoves in the Clearburn Range with the powerful Clearburn Airwash system and the large double glazed door.

Croft Clearburn Medium

CANOPY TYPE	NOMINAL STOVE OUTPUT	WIDTH	HEIGHT	DEPTH	FLUE SIZE	STANDARD LEG LENGTH	EFFICIENCY	FLUE CENTRE TOP (A)	FLUE CENTRE (B)	ENERGY EFFICIENCY CLASS
Profiled Flat Top	11Kw	680mm	685mm	490mm	150mm	150mm	75.9%	115mm	525mm	A
Rolled edge Flat Top	11Kw	700mm	685mm	490mm	150mm	150mm	75.9%	115mm	525mm	A

Croft Clearburn Large

CANOPY TYPE	NOMINAL STOVE OUTPUT	WIDTH	HEIGHT	DEPTH	FLUE SIZE	STANDARD LEG LENGTH	EFFICIENCY	FLUE CENTRE TOP (A)	FLUE CENTRE (B)	ENERGY EFFICIENCY CLASS
Profiled Flat Top	12.5Kw	725mm	685mm	520mm	150mm	150mm	72.9%	115mm	525mm	A
Rolled edge Flat Top	12.5Kw	742mm	685mm	520mm	150mm	150mm	72.9%	115mm	525mm	A

Croft Clearburn *Double Sided*

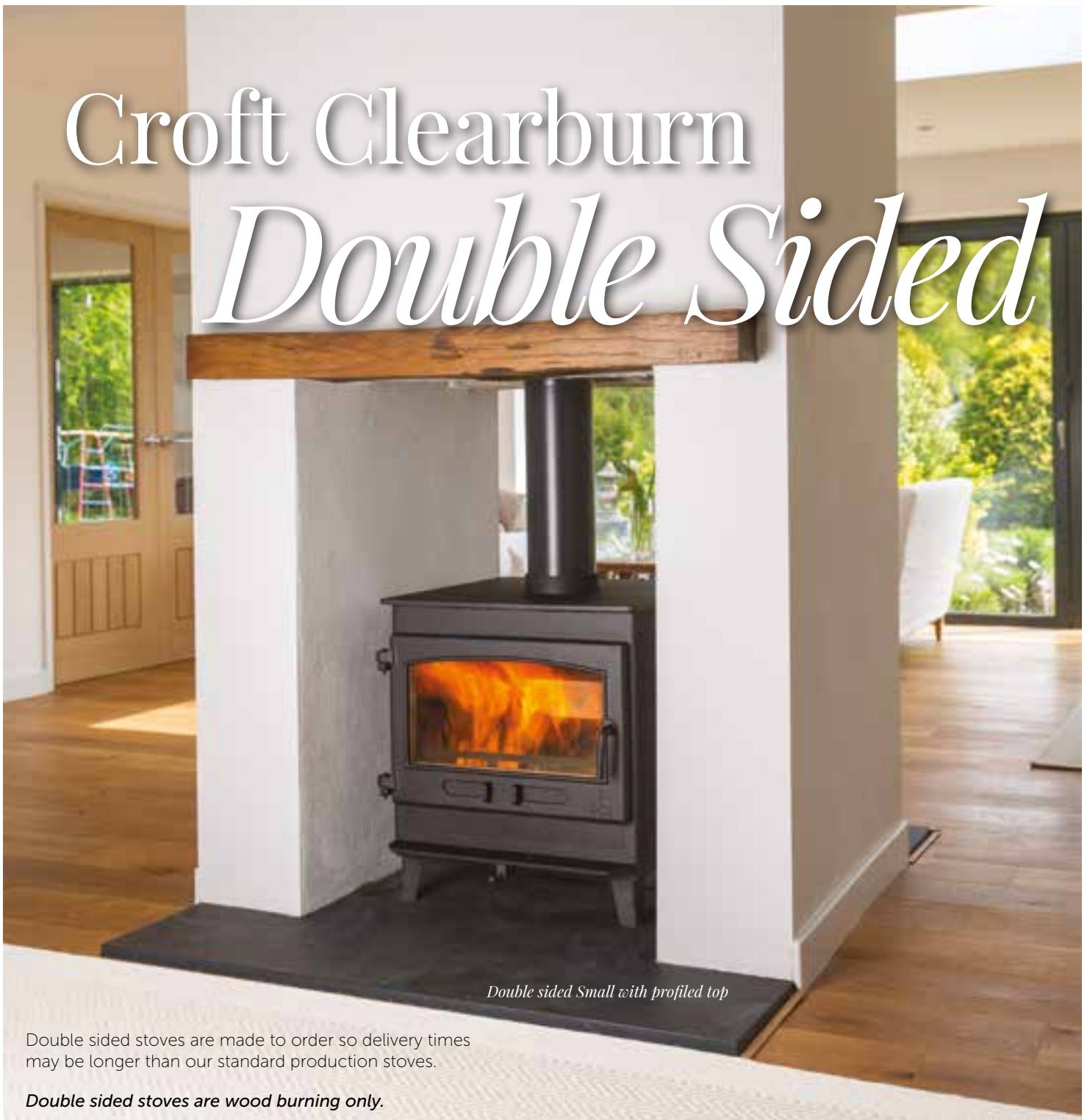

Double sided Small with profiled top

Double sided stoves are made to order so delivery times may be longer than our standard production stoves.

Double sided stoves are wood burning only.

Clearburn Double Sided Junior

CANOPY TYPE	APPROX NOMINAL OUTPUT	WIDTH	HEIGHT	DEPTH TOP	DEPTH O/A	FLUE SIZE	LEG	FLUE POSITION	EFFICIENCY	ENERGY EFFICIENCY CLASS
Profiled Flat Top	8Kw	460mm	635mm	460mm	530mm	150mm	100mm	Central	74%	A
Rolled Edge Flat Top	8Kw	490mm	635mm	460mm	530mm	150mm	100mm	Central	74%	A

Clearburn Double Sided Small

CANOPY TYPE	APPROX NOMINAL OUTPUT	WIDTH	HEIGHT	DEPTH TOP	DEPTH O/A	FLUE SIZE	LEG	FLUE POSITION	EFFICIENCY	ENERGY EFFICIENCY CLASS
Profiled Flat Top	10Kw	585mm	635mm	590mm	650mm	150mm	100mm	Central	73%	A
Rolled Edge Flat Top	10Kw	622mm	635mm	590mm	650mm	150mm	100mm	Central	73%	A

Clearburn Double Sided Medium

CANOPY TYPE	APPROX NOMINAL OUTPUT	WIDTH	HEIGHT	DEPTH TOP	DEPTH O/A	FLUE SIZE	LEG	FLUE POSITION	EFFICIENCY	ENERGY EFFICIENCY CLASS
Profiled Flat Top	12Kw	680mm	685mm	580mm	680mm	150mm	150mm	Central	73%	A
Rolled Edge Flat Top	12Kw	700mm	685mm	590mm	680mm	150mm	150mm	Central	73%	A

Sherford *Eco*

Sherford 5 *Eco* & Sherford Slimline 5 *Eco*

The Sherford Eco Range of wood burning stoves offer Eco 2022 efficiency and Dean Stoves' exceptional Airwash system, helping to maintain a clearer view of the fire.

The Sherford Eco stoves have clean lines and a large glass window for maximum view of the fire. With its stylish modern exterior, it will enrich any room contemporary or traditional.



Sherford Slimline 5 Eco Key Features:

- Eco 2022 Compliant (Ecodesign Ready)
- 5Kw Nominal Output
- New improved preheated Airwash system
- Primary and secondary air controls
- Cool touch stainless steel door handle
- Rear and top flue outlets
- **APPROVED** for use in smoke control areas

Sherford Slimline 5 Eco

Sherford 5 Eco

NOMINAL STOVE OUTPUT	WIDTH	HEIGHT	DEPTH O/A	DEPTH WITH HANDLE	FLUE SIZE	FLUE CENTRE TOP (A)	FLUE CENTRE (B)	STANDARD LEG LENGTH	EFFICIENCY	ENERGY EFFICIENCY CLASS
5Kw	451mm	640mm	365mm	415mm	125mm	135mm	495mm	100mm	82.4%	A+

Sherford Slimline 5 Eco

NOMINAL STOVE OUTPUT	WIDTH	HEIGHT	DEPTH O/A	DEPTH WITH HANDLE	FLUE SIZE	FLUE CENTRE TOP (A)	FLUE CENTRE (B)	STANDARD LEG LENGTH	EFFICIENCY	ENERGY EFFICIENCY CLASS
5Kw	576mm	640mm	345mm	395mm	125mm	135mm	495mm	100mm	81.4%	A+

Sherford 8 Eco



Sherford 8 Eco Key Features:

- Eco 2022 Compliant (Ecodesign Ready)
- 8Kw Nominal Output
- New improved preheated Airwash system
- Cool touch stainless steel door handle
- Primary and secondary air controls
- APPROVED for use in smoke control areas

Sherford 8 Eco



Sherford 5 Eco with plinth

Sherford with plinth

The Sherford 5 Eco, Slimline 5 Eco and Sherford 8 Eco now have the option of a plinth fitted below the fire door.

This plinth enhances the stove's clean contemporary lines. The plinth can be purchased with the stove or added at a later date.

Sherford 8 Eco

NOMINAL STOVE OUTPUT	WIDTH	HEIGHT	DEPTH O/A	DEPTH WITH HANDLE	FLUE SIZE	FLUE CENTRE TOP (A)	FLUE CENTRE (B)	STANDARD LEG LENGTH	EFFICIENCY	ENERGY EFFICIENCY CLASS
8Kw	576mm	640mm	410mm	460mm	150mm	145mm	500mm	100mm	75.1%	A

Sherford

High Eco



The Sherford High extends this successful range of Dean Stoves. The Sherford High Eco has been raised on elegant but substantial legs contributing to the contemporary aspect the Sherford emanates.

Sherford 5 High Eco

Sherford 5 High Eco

NOMINAL STOVE OUTPUT	WIDTH	HEIGHT	DEPTH O/A	DEPTH WITH HANDLE	FLUE SIZE	FLUE CENTRE TOP (A)	FLUE CENTRE (B)	EFFICIENCY	ENERGY EFFICIENCY CLASS
5Kw	451mm	810mm	365mm	415mm	125mm	135mm	495mm	82.4%	A+

Sherford Slimline 5 High Eco

NOMINAL STOVE OUTPUT	WIDTH	HEIGHT	DEPTH O/A	DEPTH WITH HANDLE	FLUE SIZE	FLUE CENTRE TOP (A)	FLUE CENTRE (B)	EFFICIENCY	ENERGY EFFICIENCY CLASS
5Kw	576mm	810mm	345mm	395mm	125mm	135mm	495mm	81.4%	A+

Sherford 8 High Eco

NOMINAL STOVE OUTPUT	WIDTH	HEIGHT	DEPTH O/A	DEPTH WITH HANDLE	FLUE SIZE	FLUE CENTRE TOP (A)	FLUE CENTRE (B)	EFFICIENCY	ENERGY EFFICIENCY CLASS
8Kw	576mm	810mm	410mm	460mm	150mm	145mm	500mm	75.1%	A

Baker Plus *Eco*

The new Baker Plus Eco range raises the height of the Dartmoor Baker stove creating easier access to the oven. The Dartmoor Baker Plus W5 Eco has been developed to allow a distance to combustibles of only 50mm to the rear, with a double heat shield fitted.



Baker Plus W5 Eco

Please note a DS Cool Wall would have to be used when installing close to a combustible wall in a corner.



Baker Plus 5 Eco

Dartmoor Baker Plus 5 Eco

NOMINAL STOVE OUTPUT	WIDTH	HEIGHT	DEPTH O/A	DEPTH WITH HANDLE	FLUE SIZE	FLUE CENTRE TOP (A)	FLUE CENTRE (B)	STANDARD LEG LENGTH	EFFICIENCY	ENERGY EFFICIENCY CLASS
5Kw	430mm	900mm	315mm	375mm	125mm	133mm	797mm	230mm	82.1%	A+

Dartmoor Baker Plus W5 Eco

NOMINAL STOVE OUTPUT	WIDTH	HEIGHT	DEPTH O/A	DEPTH WITH HANDLE	FLUE SIZE	FLUE CENTRE TOP (A)	FLUE CENTRE (B)	STANDARD LEG LENGTH	EFFICIENCY	ENERGY EFFICIENCY CLASS
5Kw	565mm	1000mm	320mm	375mm	125mm	133mm	835mm	255mm	83.1%	A+

Dartmoor Baker Plus 8

NOMINAL STOVE OUTPUT	WIDTH	HEIGHT	DEPTH O/A	DEPTH WITH HANDLE	FLUE SIZE	FLUE CENTRE TOP (A)	FLUE CENTRE (B)	STANDARD LEG LENGTH	EFFICIENCY	ENERGY EFFICIENCY CLASS
8Kw	565mm	1000mm	343mm	375mm	150mm	115mm	835mm	255mm	74.9%	A

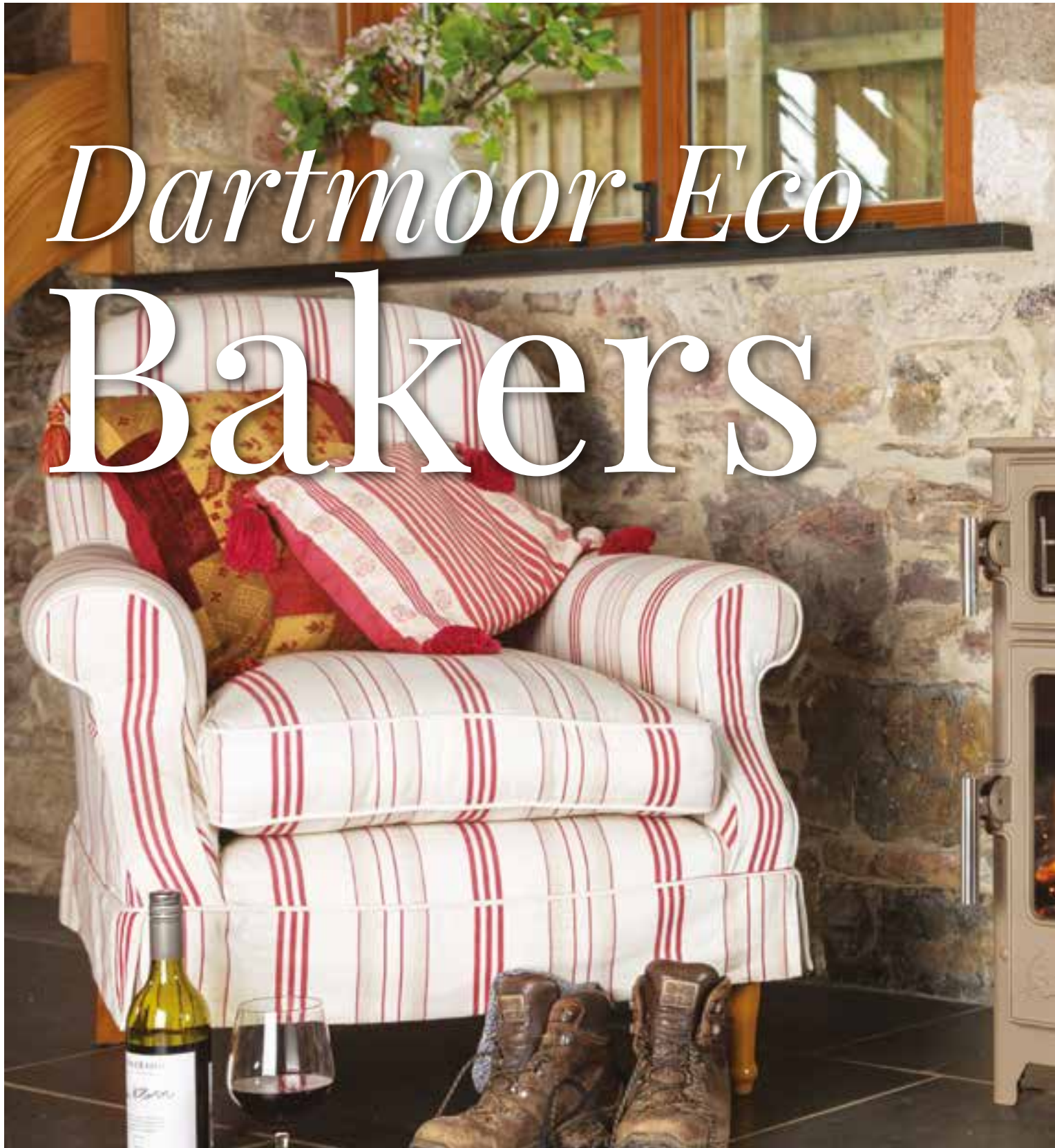

Dartmoor Eco Bakers



Oven Sizes

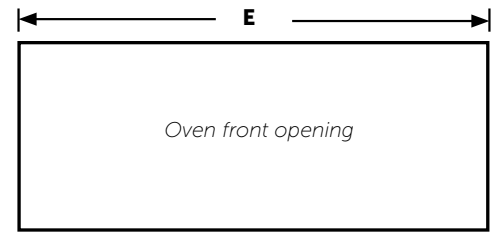
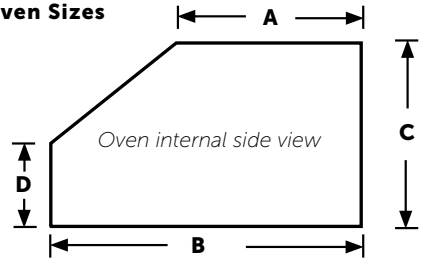

All the Dartmoor Eco Bakers can be manufactured with an extended stove top. The Baker 5 (top width +120mm); Baker W5 (+150mm); Baker 8 (+180mm), and can be configured on the left or right handside.

	A	B	C	D	E
Baker 5	155	205	150	100	280
Baker W5	140	205	180	112	410
Baker 8	177	250	180	112	410



Baker 5 Eco in Mushroom

The Dartmoor Baker Eco's have an integral oven above the fire box utilising the heat from the fire to cook bake or warm delicious food.

The Dartmoor Baker Eco's have oven vents which allow the cooking smells and condensation to be drawn out of the oven and up the chimney. Using the rear flue outlet will create a clear area, providing extra space and access to the hotter part of the top plate (near the back), a special Dartmoor Baker Eco back adaptor with flue cleaning access can be purchased to achieve this.

All the Dartmoor Baker Eco's have a removable cleaning plate located inside the oven. This door provides a cleaning access to the top of the oven or for sweeping the chimney when fitted with a top exit flue. Check your chimney sweep is happy to sweep through this access door before installation. The Dartmoor Baker W5 Eco has been developed to allow a distance to combustibles of only 50mm to the rear, with a double heat shield fitted.

The Baker stoves come with stainless steel handles only.

Both the Baker 5 Eco and Baker W5 Eco are Eco 2022 Compliant and are approved for use in smoke control areas.

Dartmoor Baker 5 Eco

NOMINAL STOVE OUTPUT	WIDTH	HEIGHT	DEPTH O/A	DEPTH WITH HANDLE	FLUE SIZE	FLUE CENTRE TOP (A)	FLUE CENTRE (B)	STANDARD LEG LENGTH	EFFICIENCY	ENERGY EFFICIENCY CLASS
5Kw	430mm	720mm	315mm	375mm	125mm	133mm	618mm	50mm	82.1%	A+

Dartmoor Baker W5 Eco

NOMINAL STOVE OUTPUT	WIDTH	HEIGHT	DEPTH O/A	DEPTH WITH HANDLE	FLUE SIZE	FLUE CENTRE TOP (A)	FLUE CENTRE (B)	STANDARD LEG LENGTH	EFFICIENCY	ENERGY EFFICIENCY CLASS
5Kw	565mm	850mm	320mm	375mm	125mm	133mm	685mm	105mm	83.1%	A+

Dartmoor Baker 8 Se

NOMINAL STOVE OUTPUT	WIDTH	HEIGHT	DEPTH O/A	DEPTH WITH HANDLE	FLUE SIZE	FLUE CENTRE TOP (A)	FLUE CENTRE (B)	STANDARD LEG LENGTH	EFFICIENCY	ENERGY EFFICIENCY CLASS
8Kw	565mm	850mm	343mm	375mm	150mm	115mm	685mm	105mm	74.9%	A

Inset Range

105 Eco Inset



The 105 Eco inset stove is designed to be installed into a standard fireplace opening with the chair brick removed. With its large curved glass window and powerful Airwash system, the 105 Eco allows a maximum view of the fire.

The 105 Eco inset stove is Ecodesign Ready and satisfies all the stringent emission requirements. It has ducting built into all sides of the fire box encouraging cold air to be drawn into the underside of the stove, heated up throughout the ducting and naturally convected into the room through the top and side venting. To further improve control and efficiency when burning wood, the 105 Eco inset is fitted with the Dean Stoves wood burning plate as standard (this plate must be removed when burning solid fuel).

Key Features

- Eco 2022 Compliant (Ecodesign Ready)
- 5Kw nominal output
- Powerful Airwash system
- Large curved glass window
- Multi-Fuel
- Double skin convector box to all sides of the fire box
- **APPROVED** for use in smoke controlled areas
- Wood burning plate
- Supplied with surround frame for the wider fireplaces

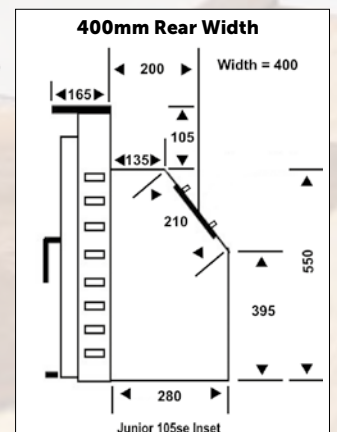

Junior 105 Eco Inset

NOMINAL STOVE OUTPUT	WIDTH	WIDTH WITH SURROUND FRAME	HEIGHT	OVERALL DEPTH	FLUE SIZE	EFFICIENCY	ENERGY EFFICIENCY CLASS
5Kw	450mm	495mm	655mm	450mm	125mm	78%	A



Dartmoor 5 Inset

The pre-heated Airwash system, designed to keep the glass clean and secondary burning of exhaust gases, multi-fuel riddling grate option and superb fuel efficiency make these traditional stoves among the most efficient inset stoves available.

Incorporating all the features of the Clearburn range, these great little inset wood burning or multifuel stoves have been designed to fit into an existing fireplace, often saving on building works to re-model your existing fireplace and hearth depth.



Croft Inset



Herrick Inset

Key Features

- Incorporating all the features of the Clearburn Range
- Double skin convector
- Preheated Airwash system
- Designed to fit into a standard 16" (200mm) fireplace (with fire back removed)
- Handle options. Bar, cage or stainless steel *
- Drop in external riddling multi-fuel grate
- Double glazed heavy cast iron door *
- 5mm steel refractory lined fire box
- 82% efficient
- 5Kw nominal output
- 125mm flue outlet

* Croft and Herrick only.

Dartmoor 5 Inset

CANOPY TYPE	NOMINAL STOVE OUTPUT	WIDTH	HEIGHT	OVERALL DEPTH	FLUE SIZE	STANDARD LEG LENGTH	EFFICIENCY	ENERGY EFFICIENCY CLASS
Profiled Flat Top with extra extension frame	5Kw	495mm	580mm	330mm	125mm	–	82%	A
Profiled Flat Top without extra extension frame	5Kw	480mm	563mm	330mm	125mm	–	82%	A

Croft Inset

CANOPY TYPE	NOMINAL STOVE OUTPUT	WIDTH	HEIGHT	OVERALL DEPTH	FLUE SIZE	STANDARD LEG LENGTH	EFFICIENCY	ENERGY EFFICIENCY CLASS
Profiled Flat Top	5Kw	520mm	563mm	372mm	125mm	–	82%	A

Herrick Inset

CANOPY TYPE	NOMINAL STOVE OUTPUT	WIDTH	HEIGHT	OVERALL DEPTH	FLUE SIZE	STANDARD LEG LENGTH	EFFICIENCY	ENERGY EFFICIENCY CLASS
Low Canopy	5Kw	520mm	622mm	372mm	125mm	–	82%	A

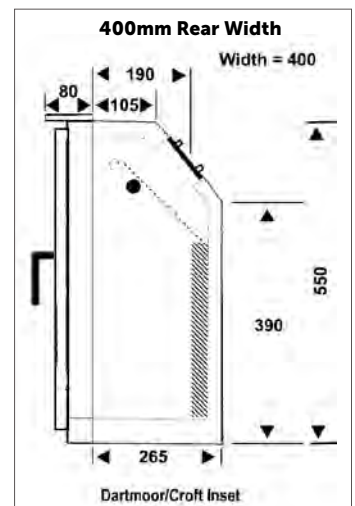

DS Cool Wall

A Dean Stove can be installed only 50mm away from DS Cool Wall with a combustible wall behind.

Wood burning stoves have become increasingly efficient, designed to harvest the maximum energy from the fuel and distribute as much heat as possible into the room. With today's building materials and building methods, house walls are designed to be quickly built with high insulation properties. When it comes to installing wood or multi-fuel stoves these materials are often flammable making it unsafe and illegal to install a stove in front or to the side. All CE

tested and approved stoves will have gone through an over fire test, often bringing the stove to a point where it will glow red hot. This test will determine how far from combustible materials the stove can be installed. Some stove companies will restrict the primary and secondary combustion air to reduce the heat produced on this test, but this can impede the performance of the stove.

Dean Stoves have decided not to restrict the combustion air and have developed the DS Cool Wall. Under test the DS Cool Wall recorded temperatures of more than 600°C behind the stove with a rise in room temperature behind the DS Cool Wall of only 4°C.

The DS Cool Wall comes in high temperature Black.



DS Cool Wall

MODEL	WIDTH	HEIGHT	DEPTH
SMALL	750mm	800mm	80mm
MEDIUM	900mm	1100mm	80mm
LARGE	1200mm	1100mm	80mm

Information & Options

Door Handles & Control Knobs

The Clearburn Range of stoves come as standard with a black bar handle and black control knob but also have the option of cage or stainless steel handles and brass or stainless steel secondary air control knob. Although we recommend the use of a glove when operating the stove the cage will stay cooler than the black bar or stainless steel handle. Please state which options you would like when ordering your stove.



BLACK AIR CONTROL KNOB



BRASS AIR CONTROL KNOB



STAINLESS STEEL KNOB



BLACK BAR DOOR HANDLE



CAGE DOOR HANDLE



STAINLESS STEEL HANDLE

Dartmoor Handles

The Dartmoor Range of stoves come as standard with a black cast handle or can be ordered with a stainless steel handle, at a small additional cost. All special colour stoves and the Baker stoves will be fitted with stainless steel handles.



Sherford & Woodbury Handles

Stainless handles are supplied as standard for the Sherford and Woodbury models.



Available colours



CHAMPAGNE



GREY



DORY BLUE



CHARCOAL



HONEY GLOW BROWN



FIRECRACKER RED



MOJAVE RED



MUSHROOM

Please note

All heat resistant paint will change colour shades when the stove is put under fire and the paint is fully cured. Some of the lighter colours will noticeably vary in shade where the stove naturally has cooler areas, the Dartmoor Baker is one such stove.

The Clearburn Range is restricted to a colour choice of Charcoal, Dory Blue, Honey Glow Brown and Grey.

Information & Options *continued*

Clear Vision of Fire

Dean Stoves Clearburn, Woodbury, Sherford and 105Se ranges incorporate a preheated Airwash system. This system is designed to heat the secondary air to a very high temperature before being drawn over the glass.

The stove induces pre-heated air from the bottom of the stove through a labyrinth of passages into the top of the stove and over the glazed door, this drives unburnt gases back into the fire chamber mixing with the air at the same time.

These gases combined with the hot air cause combustion over the glass, burning more fuel particles and unwanted deposits off the glass; thus increasing the efficiency and vision of the fire.

Legs

All Junior, Slimline and Small Clearburn stoves are fitted with 100mm legs and all Clearburn stoves in the medium and large ranges are fitted with 150mm legs as standard giving their standard height in the tables.

Airwash System

The Woodbury, Sherford and Clearburn range of stoves have an Airwash system which is unlike many other stoves on the market. The secondary air is taken through the base of the stove where it starts to absorb heat, it then continues through special air ducts at the back of the stove taking on more heat. At this point some of the air is directed through air ways in the back of the stove, this air is delivered above the flames to ignite unburnt gasses and further reduce particles. The remaining air is further heated in the top of the stove then drawn over the glass to burn unwanted deposits off the glass, continuing to the fire bed supplying air to the burning fuel.

Flue Options

There are three flue arrangements available – top, rear and back box.

Top and rear flue options are fitted as standard on all Dean Stoves. This is achieved by moving the interchangeable flue spigot and cover plate to either the top or the back.

The back box (see illustration) is an optional extra, this is fixed to the back outlet on the stove, using the same fixing point as the standard spigot, and enabling the stove to be brought forward in the fireplace and the top kept clear, whilst using a vertical flue. This option also eliminates the use of a tee and cap, with the added facility in most cases to still clean the flue through the stove.

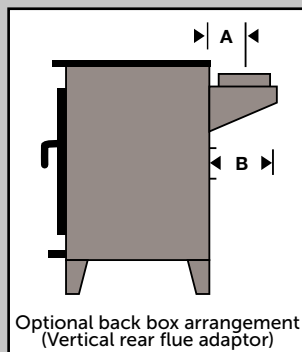

Optional back box arrangement (Vertical rear flue adaptor)

DIMENSION A	DIMENSION B
125mm outlet 90mm	125mm outlet 180mm
150mm outlet 105mm	150mm outlet 210mm

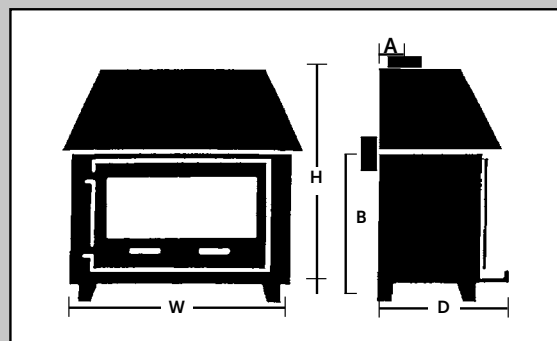

Multi-fuel Options

The Woodbury 5 and Woodbury Slimline 5 are supplied as two options, wood only and multi-fuel models. The Sherford and Clearburn ranges along with the Woodbury 8 are supplied as wood burning only models.

Hearth Requirements and Stove Installation

All Dean Stoves built after February 2022 are able to be installed on a minimum of 12mm non-combustible hearth to meet current building regulation. Please refer to installation instructions and current building regulations before installing your stove.

Dean Stoves recommend all stove installations are carried out by an experienced HETAS qualified engineer.

Stove Finish

Stoves are finished with a high quality heat resistant paint. Flat black is our standard colour for all of our stoves. A range of colours (see opposite page) are available on all stoves except the Clearburn range.

Fuel

All stoves will burn wood, peat and brickettes. Stoves fitted with multi-fuel grates will burn all types of smokeless fuel recommended for enclosed appliances.

As with all wood burning stoves the wood you burn must have a moisture content of less than 20%. It is imperative the wood you use should have at least one year's air drying in a covered position before use on any stove.

Closed Combustion

The Clearburn, Sherford and Woodbury ranges can be fitted with a direct air manifold enabling combustion air to be connected directly to an outside air source.

By using the Closed Combustion system you prevent the stove from stealing heat from the room thus maximising the heat efficiency of the stove.

Guarantee

Dean Forge Fabrications Ltd offers a five year guarantee which covers the main body of the stove for manufacturing defects.

To calculate heat requirement for your room

A good rule of thumb guide to calculate the heat requirement of a given room is:

$$\begin{aligned} & \text{HEIGHT} \\ & \times \\ & \text{WIDTH} \\ & \times \\ & \text{DEPTH (in feet)} \\ & \div \end{aligned}$$

500 (for metres divide by **14**)

This gives you the kilowatt requirement.

This is based on average house insulation with room temperatures of 20°C and an ambient temperature of -1°C.

Well-insulated houses could replace the division of 500 with 650.

Please note

All heat resistant paint will change colour shades when the stove is put under fire and the paint is fully cured. Some of the lighter colours will noticeably vary in shade where the stove naturally has cooler areas, the Dartmoor Baker is one such stove.

The Clearburn Range is restricted to a colour choice of Charcoal, Dory Blue, Honey Glow Brown and Grey.

The illustrations in this brochure do not necessarily comply with local building regulations.

Due to the limitations of the print process actual colours may vary.



Dean Forge

Distance to combustibles (mm)

Stove	ECO MODEL			STANDARD MODEL		
	Rear of Stove	Side of Stove	With double heat shield	Rear of Stove	Side of Stove	With rear heat shield
Dartmoor 5 Eco	150	550	—	—	—	—
Dartmoor W5 Eco	200	350	50	—	—	—
Dartmoor 8	—	—	—	900	600	475
Huccaby Eco	200	350	50	—	—	—
Foxworthy High Eco	150	550	—	—	—	—
Foxworthy Low Eco	150	550	—	—	—	—
Clearburn Junior Eco	200	400	—	—	—	—
Clearburn Slimline 5 Eco	250	500	—	*	—	—
Clearburn Small Eco	300	300	—	—	—	—
Clearburn Medium	—	—	—	1000	700	—
Clearburn Large	—	—	—	1200	800	—
Clearburn Junior Double Sided	—	—	—	n/a	800	—
Clearburn Small Double Sided	—	—	—	n/a	950	—
Clearburn Medium Double Sided	—	—	—	n/a	950	—
Sherford 5 Eco	200	400	—	—	—	—
Sherford Slimline 5 Eco	250	500	—	—	—	—
Sherford 8 Eco	300	400	—	—	—	—
Sherford 5 High Eco	200	400	—	—	—	—
Sherford Slimline 5 High Eco	250	500	—	—	—	—
Sherford 8 High Eco	300	400	—	—	—	—
Woodbury 5 Eco	200	400	—	—	—	—
Woodbury Slimline Eco	250	500	—	—	—	—
Woodbury 8 Eco	300	400	—	—	—	—
Dartmoor Baker 5 Eco	150	550	—	—	—	—
Dartmoor Baker W5 Eco	200	350	50	—	—	—
Dartmoor Baker 8 Eco	—	—	—	900	600	475
Dartmoor Baker Plus 5 Eco	150	550	—	—	—	—
Dartmoor Baker Plus W5 Eco	200	350	50	—	—	—
Dartmoor Baker Plus 8	—	—	—	900	600	475

Inset Stoves	ECO MODEL			STANDARD MODEL		
	Rear of Stove	Side of Stove	Above stove	Rear of Stove	Side of Stove	Above stove
Inset 105 Eco	n/a	200	400	—	—	—
Dartmoor 5 Inset	n/a	—	—	n/a	250	250
Croft Clearburn Inset	n/a	—	—	n/a	250	250
Herrick Inset	n/a	—	—	n/a	250	250

Croft Clearburn Top Options

All Croft Clearburn stoves have the option of a profiled flat top or a rolled edge flat top. As with all the Clearburn range, options of cage, bar or stainless steel handle and black, brass or stainless steel secondary air control knobs are available. See illustration page.



CROFT CLEARBURN JUNIOR WITH PROFILE TOP



CROFT CLEARBURN JUNIOR WITH ROLLED EDGE TOP

Dean Forge was established by Michael Chew in 1969 in the small village of Dean Prior nestling on the edge of Dartmoor.

Robert Herrick, the Royalist poet was vicar of Dean Prior during the 17th Century and the village is still an attraction for many devotees of his work, much of it written at Dean Prior.

In 1978, when Dean Forge first designed and manufactured wood burning stoves, the very local nature of this business was reflected in the name of the first range – Herrick Stoves.

With over 50 years in engineering and manufacturing Dean Forge has always been a family run business. Michael, his sons and other dedicated long standing local members of staff have amassed vast expertise and experience in manufacturing and installing wood and multi-fuel stoves.

All Dean Stoves are manufactured at Dean Forge in Devon with the cast iron door cast in a British foundry.

The Lysa Range of Woodburning Stoves



With modern timeless Swedish design and efficiency these models boasts the latest combustion technology.

Ask for our separate Lysa brochure from Dean Stoves.

Accessories

Handmade accessories by Dean Forge, Log Rings, Log Cradle, Fireside Companion Sets and Tools, Boot Racks and Coat Hooks.





Dean Forge



Bowhill House, Exeter

Dean Forge Fabrications Ltd

Dean Prior, Buckfastleigh,
Devon TQ11 0LS

Trade Counter

Telephone: 01364 643574
Facsimile: 01364 643982
Email: stoves@deanforge.co.uk

Dean Stoves has a policy of continuous development and reserve the right to change the specification on the stoves without further notice.

www.deanforge.co.uk



Dealer's Stamp

The illustrations in this brochure do not necessarily comply with local building regulations. Due to the limitations of the print process actual colours may vary. Dean Stoves would like to thank all the customers that have allowed us into their homes to photograph their installed Dean Stoves.